

CORSO ARDUINO

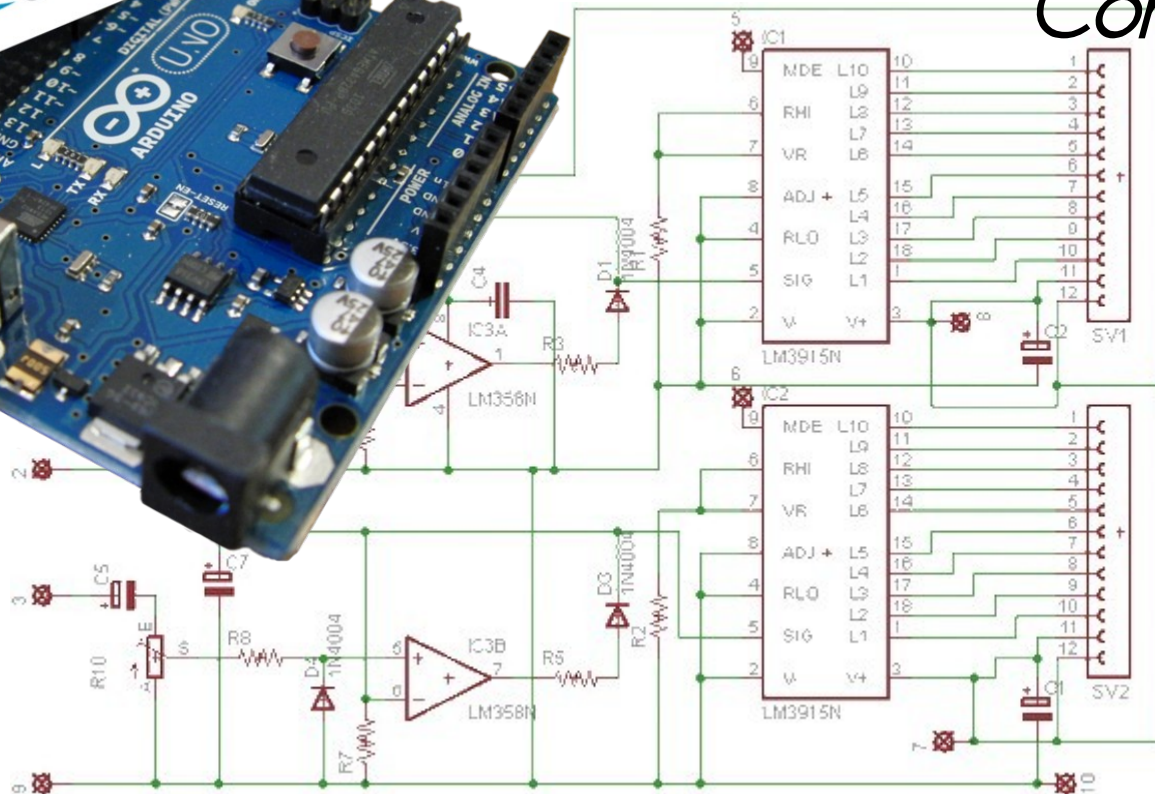

Giulio Fieramosca
Stefano Panichi
Corso ASEV 2015

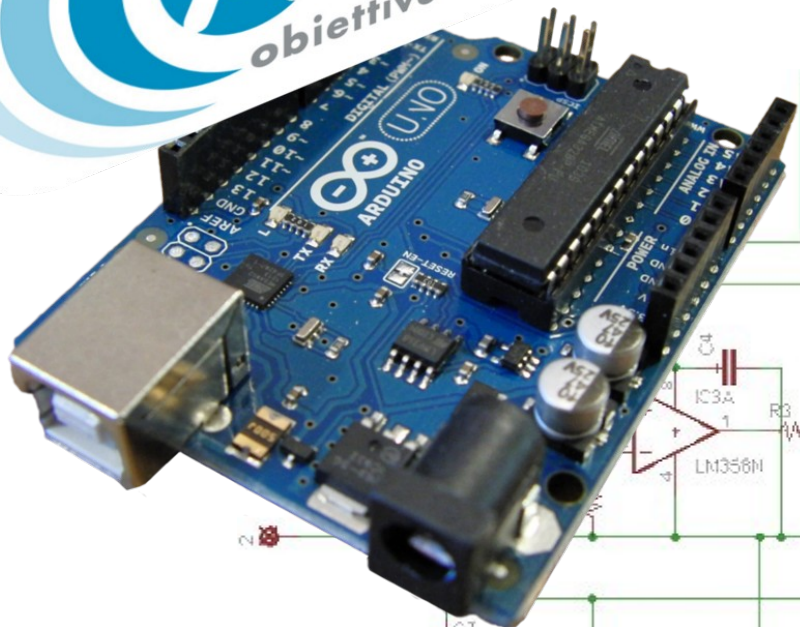

Di cosa parliamo oggi...

Sensoristica complessa: i protocolli di comunicazione;

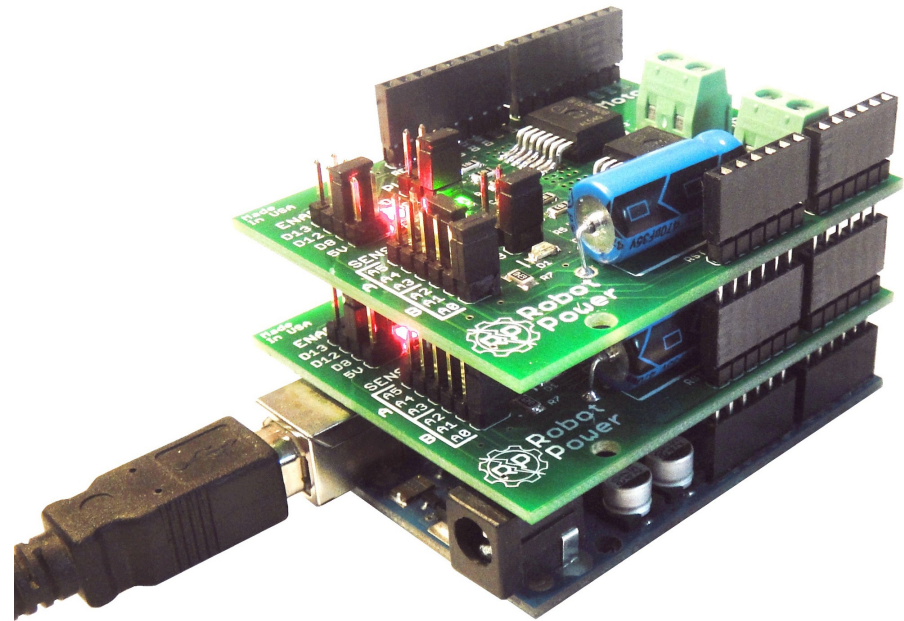
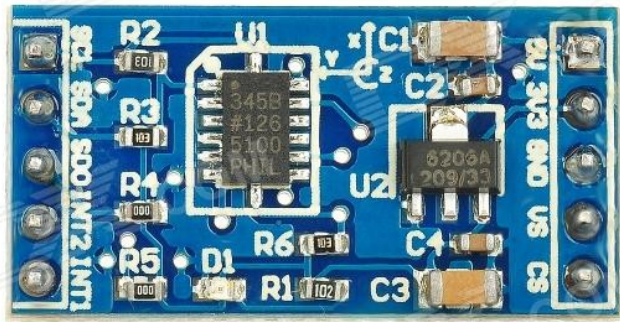

Shield per Arduino: circuiti avanzati pronti all'uso.

Protocolli di comunicazione

I microcontrollori dispongono di alcune periferiche in grado di gestire dei protocolli di comunicazione complessi:

- **Seriale:** TX/RX
- **I²C:** SDA/SCL
- **OneWire:** DAT
- **SPI:** MISO/MOSI/SCK/SS

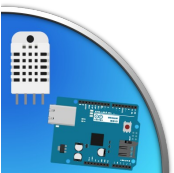
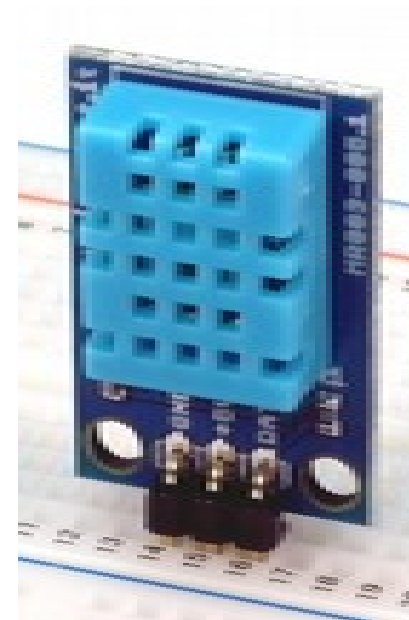

Seriale (asincrona)

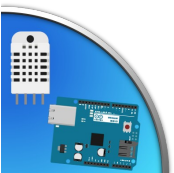
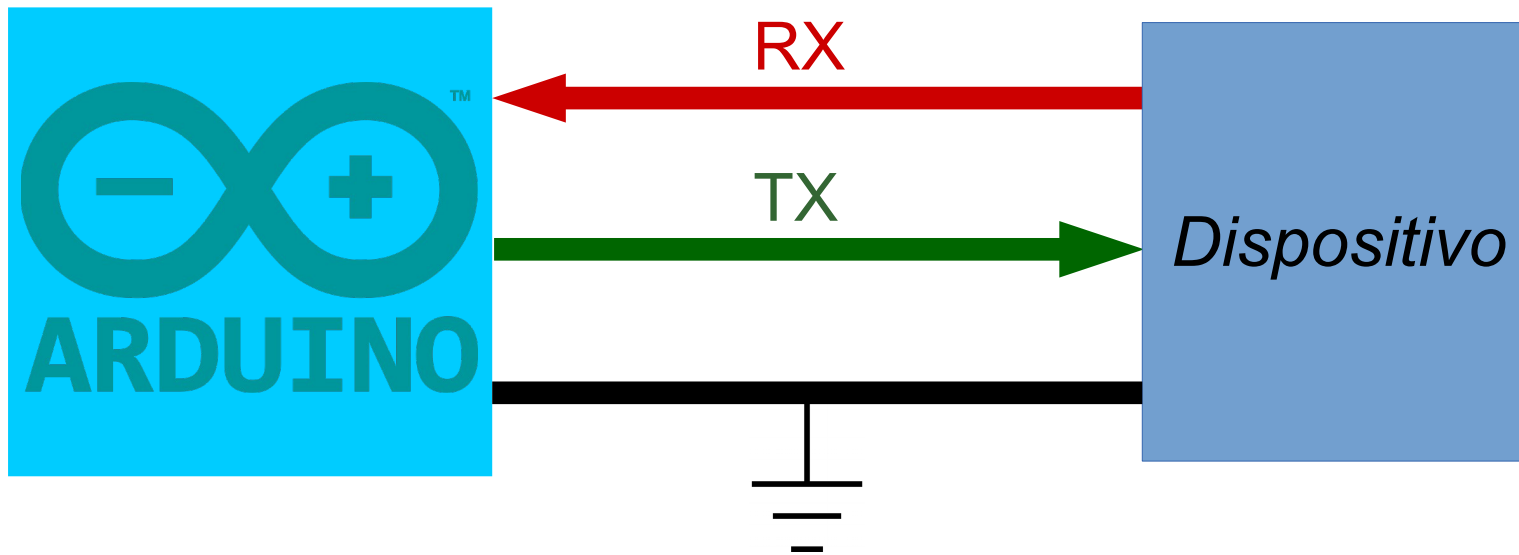

Seriale: xBee

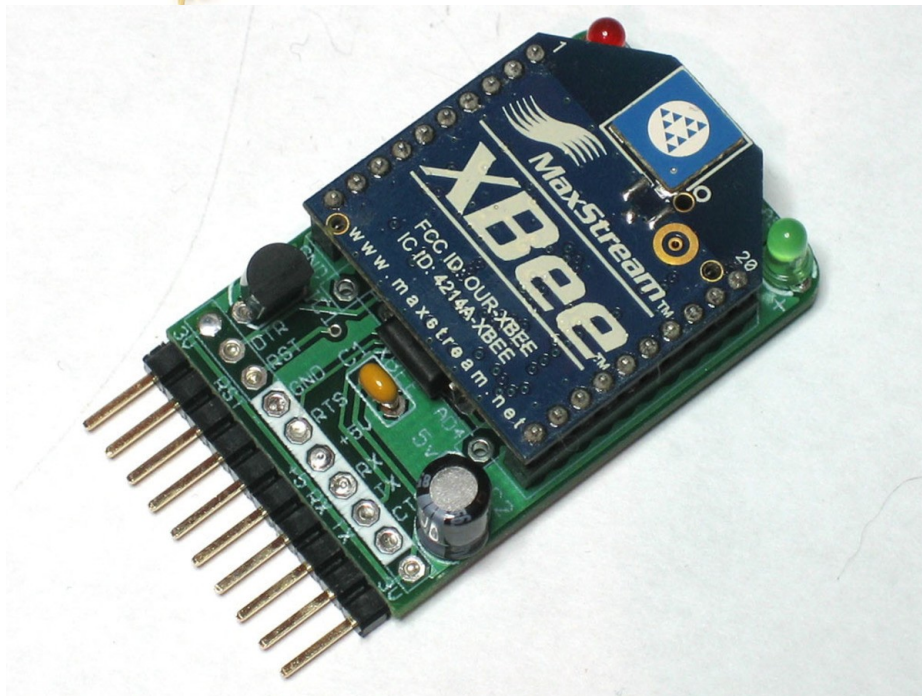
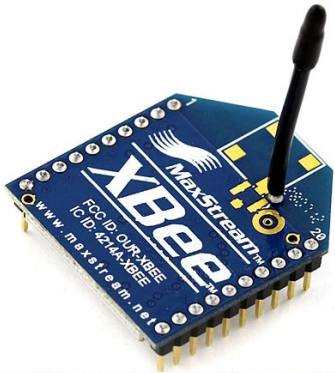

- Modulo radio a 800kHz ~ 2.4GHz;
- Comunica con altri xBee aventi stesso ID impostato;
- Tramite un adattatore o uno shield, è possibile usare il *protocollo seriale* per inviare e ricevere dati senza fili.

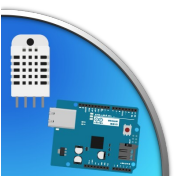
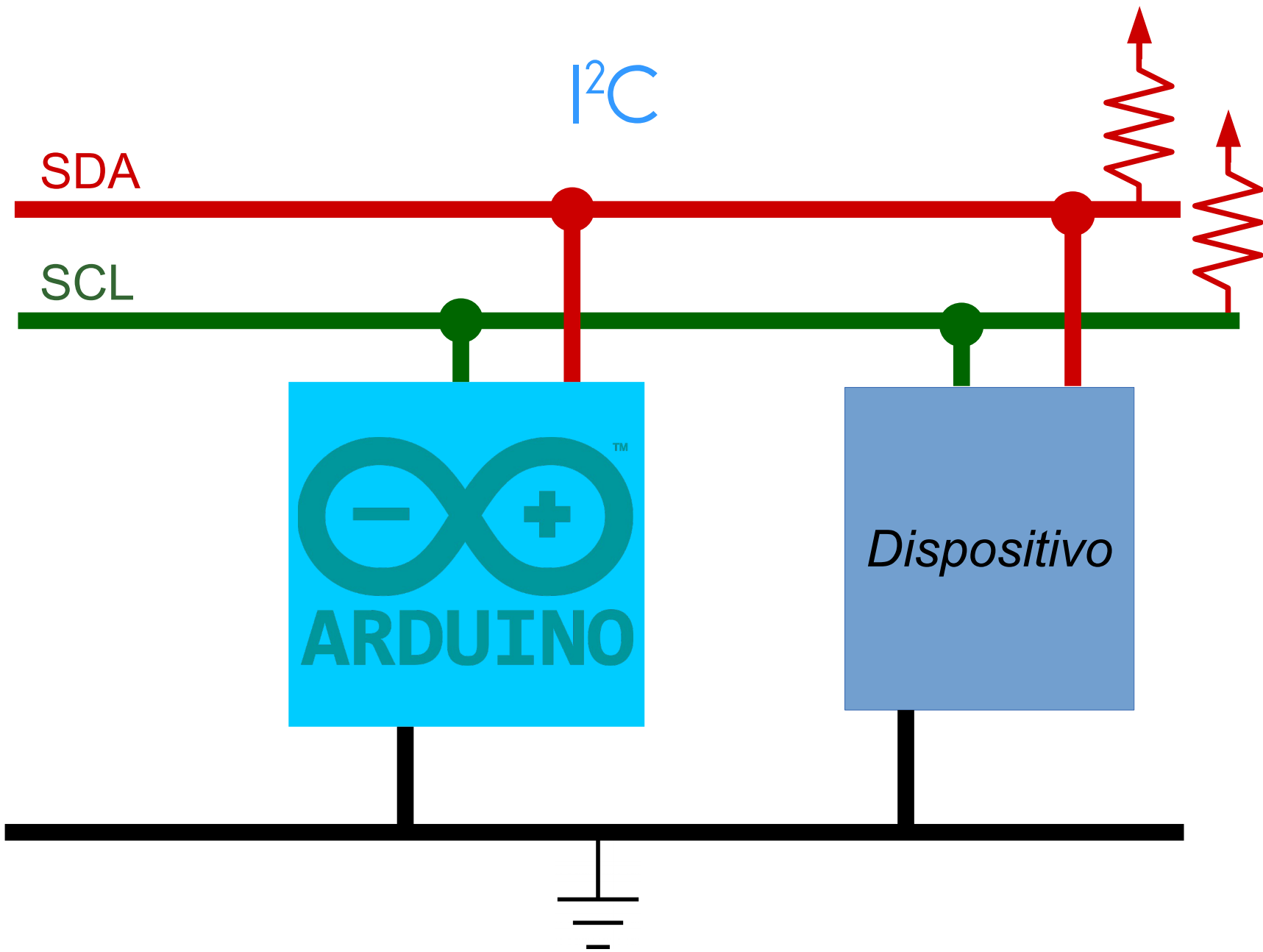

Accelerometro MPU 6050

- Sensore I²C con giroscopio e accelerometro 3 assi
- Anche in questo caso è necessaria una libreria che decodifichi le informazioni, secondo tale protocollo;

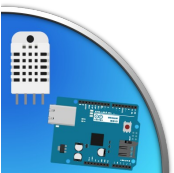

SPI

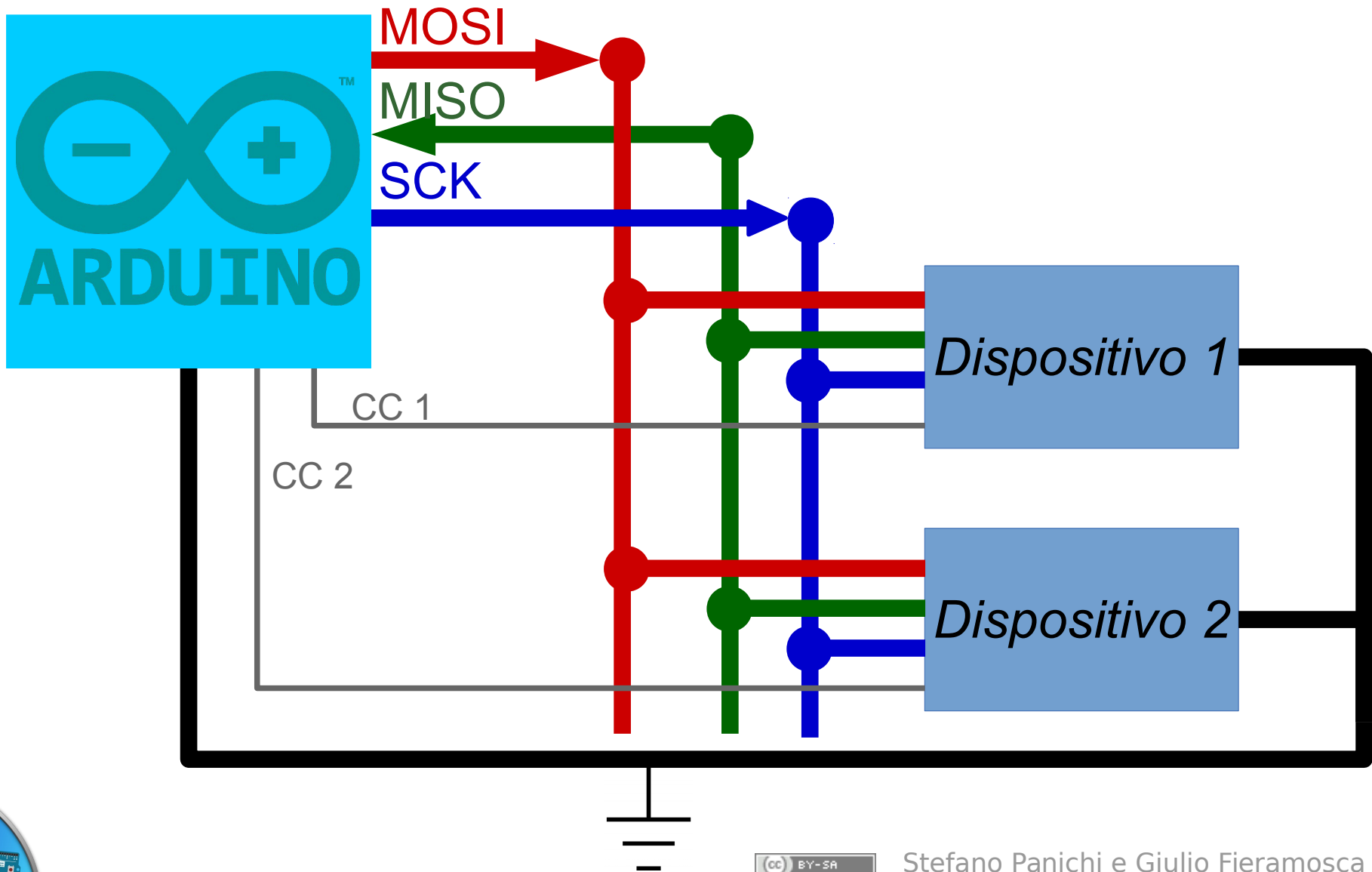

One Wire

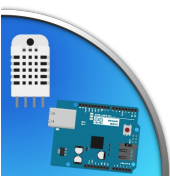
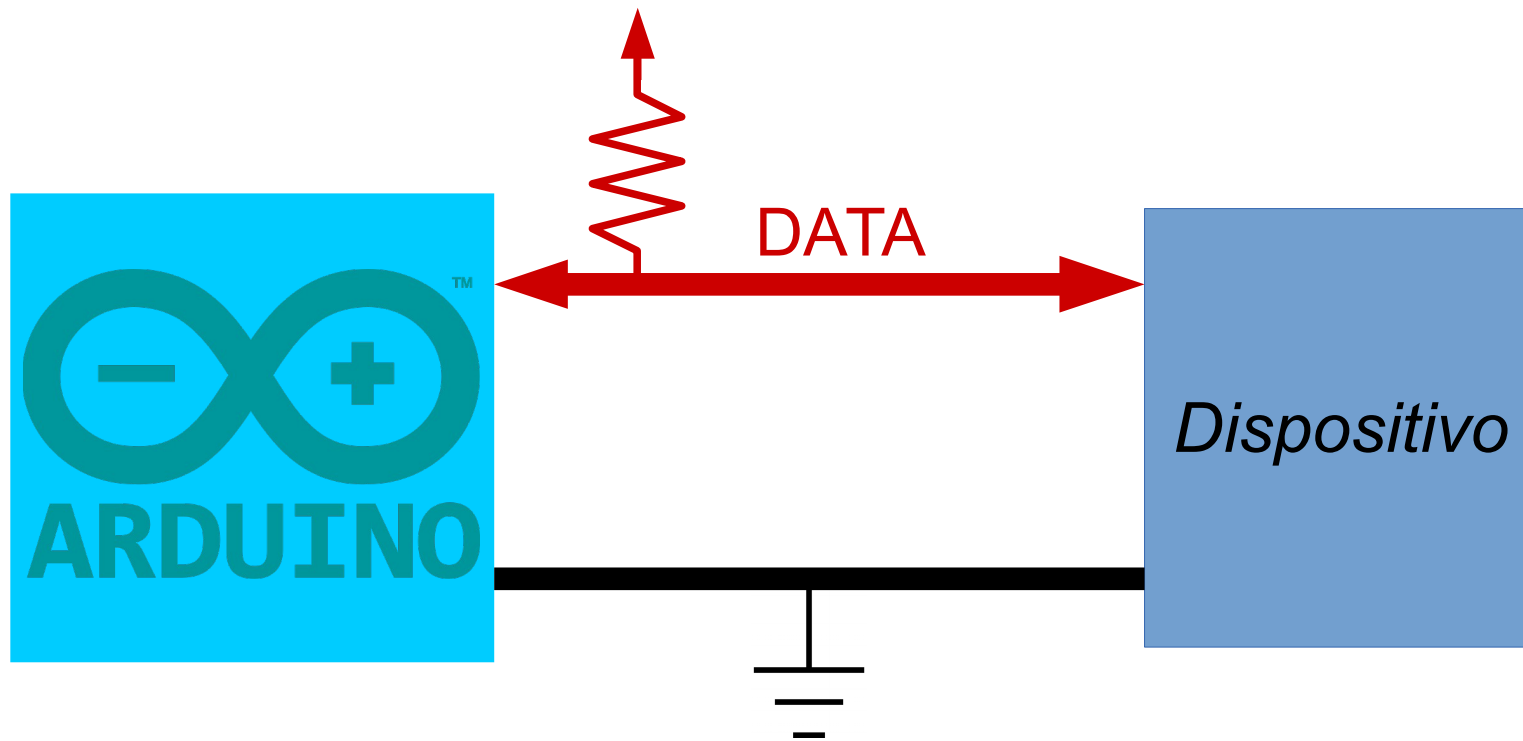

DHT11 – Sensore di temperatura e umidità

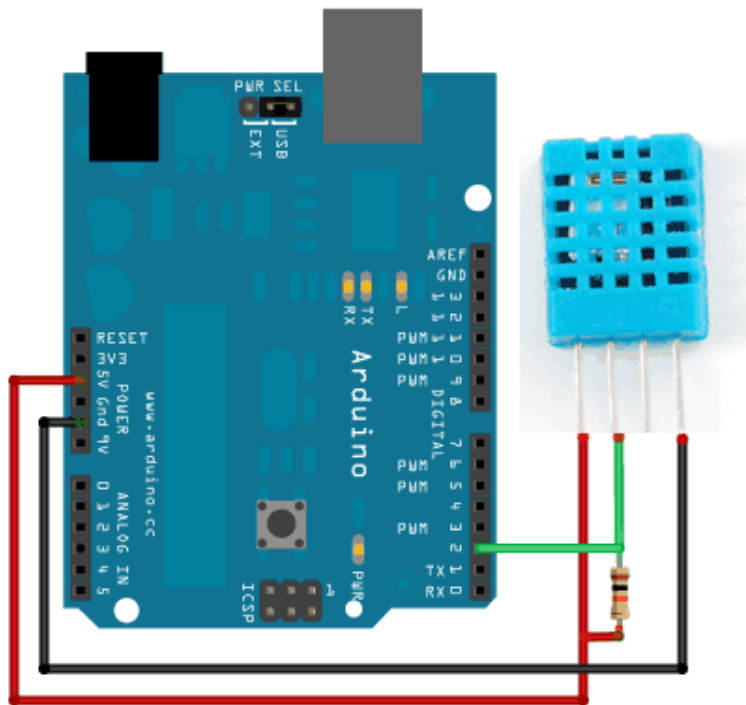

- Sensore che comunica con protocollo OneWire;
- Le informazioni in output, ricevute sul pin 2 di Arduino, vanno decodificate attraverso un'apposita libreria.

Sensore a ultrasuoni SRF05

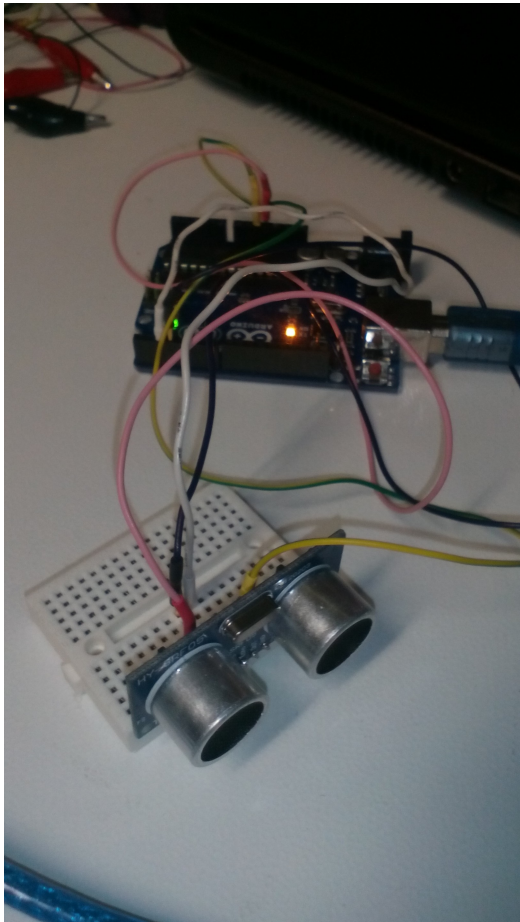

- Protocollo di comunicazione a larghezza d'impulso;
- Si invia un impulso sul pin trigger, e il sensore risponde sul pin echo con un segnale alto, lungo quanto la distanza misurata.

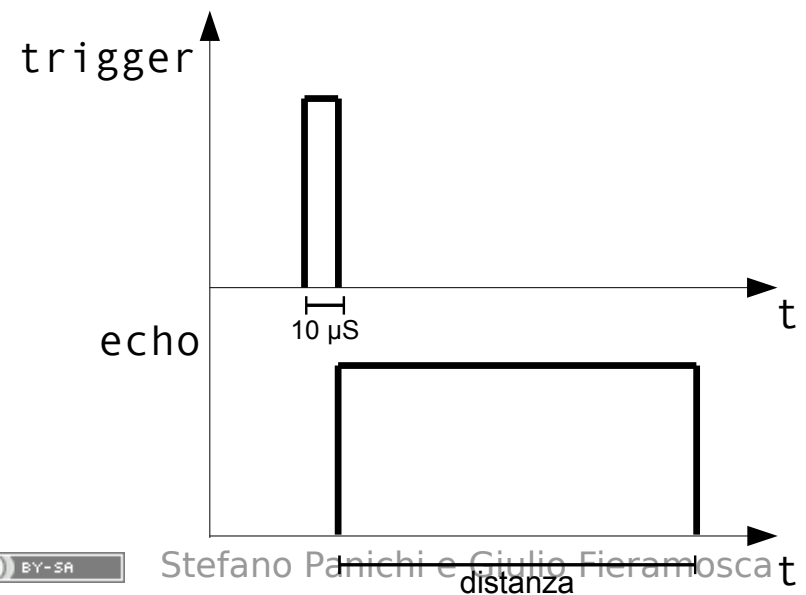

Shields

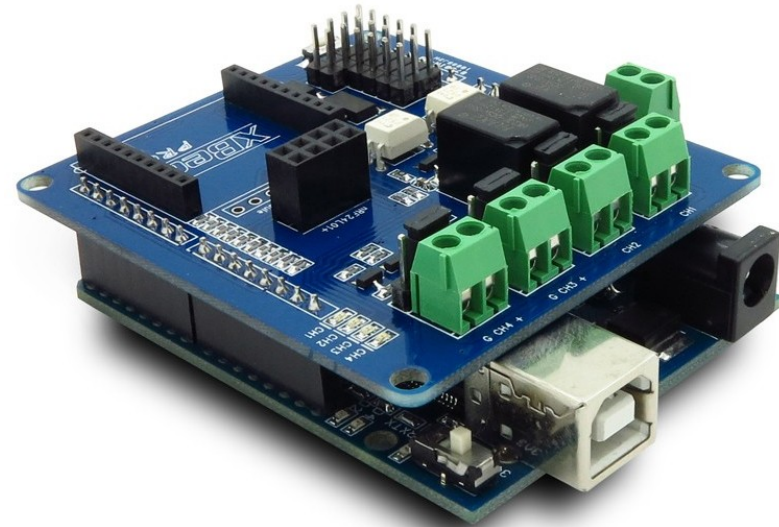
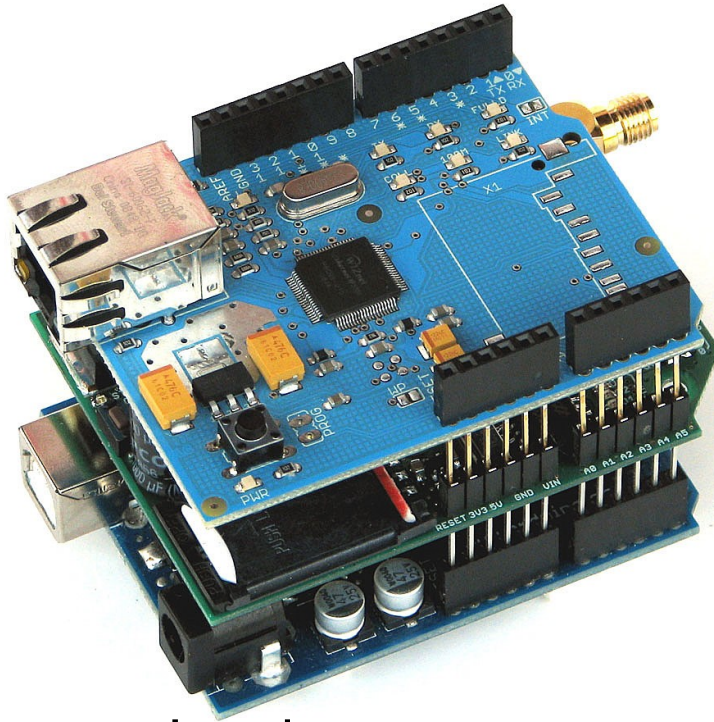

Sono schede progettate appositamente per essere inserite su Arduino, hanno infatti una piedinatura corrispondente. Più shields possono essere impilati uno sull'altro.

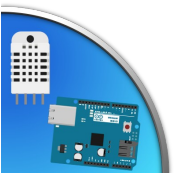

Ethernet Shield

- Scheda che aggiunge un collegamento ethernet ad Arduino, con cui è possibile sia leggere informazioni su server esterni, sia inviare dati in rete;
- Comunica in SPI, è presente nell'IDE l'apposita libreria;



GSM Shield



WiFi Shield

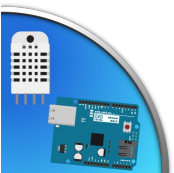
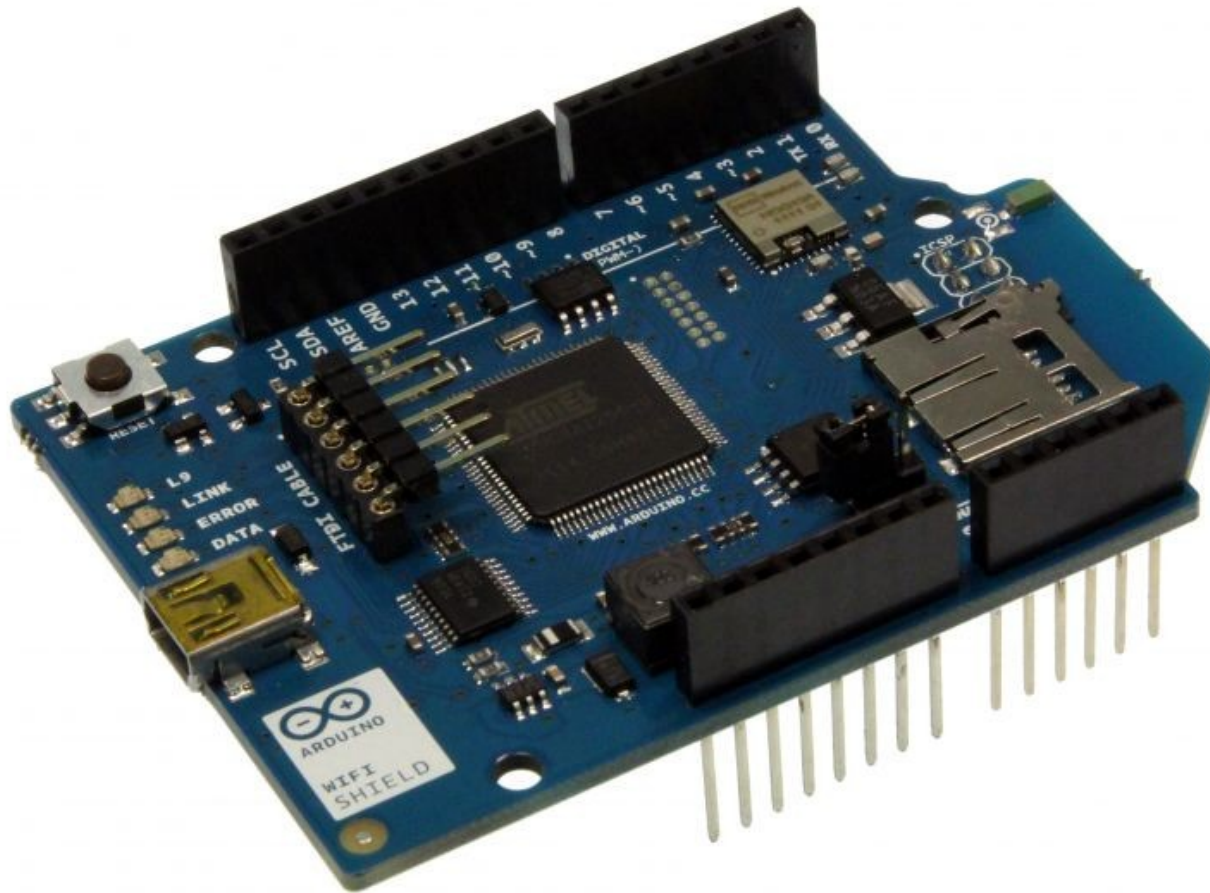

XBee Shield

Wireless proto shield with XBee module fitted
Note: XBee module not included

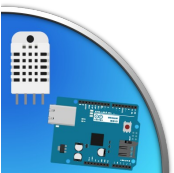
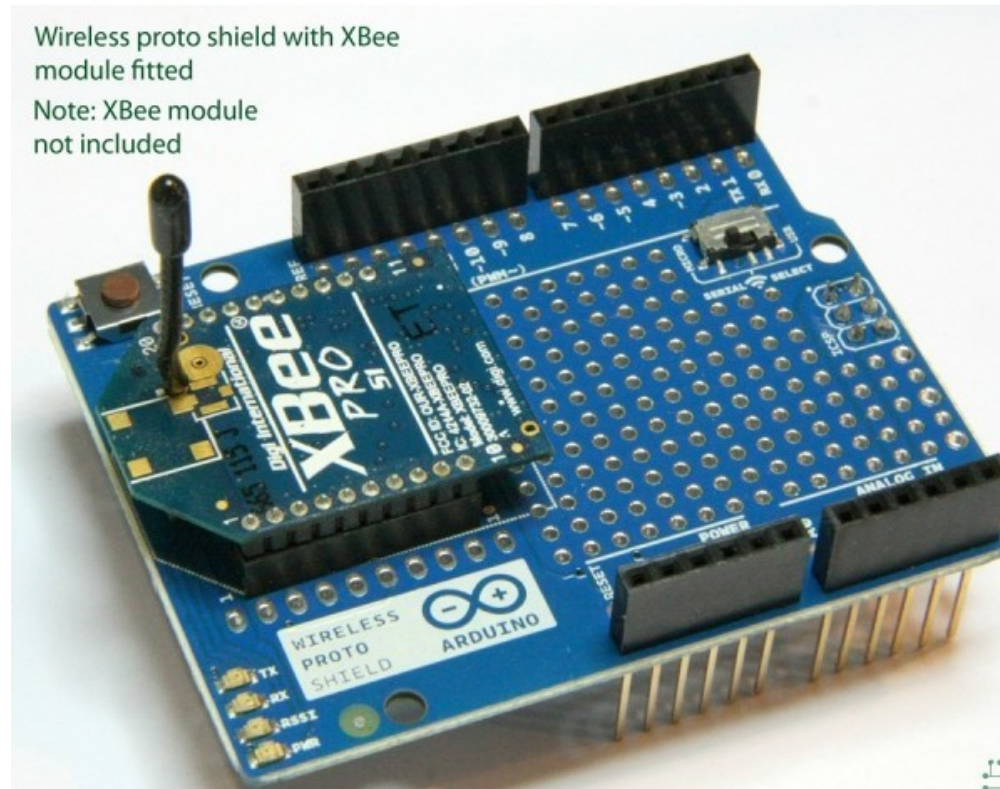

RFID Shield

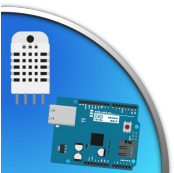
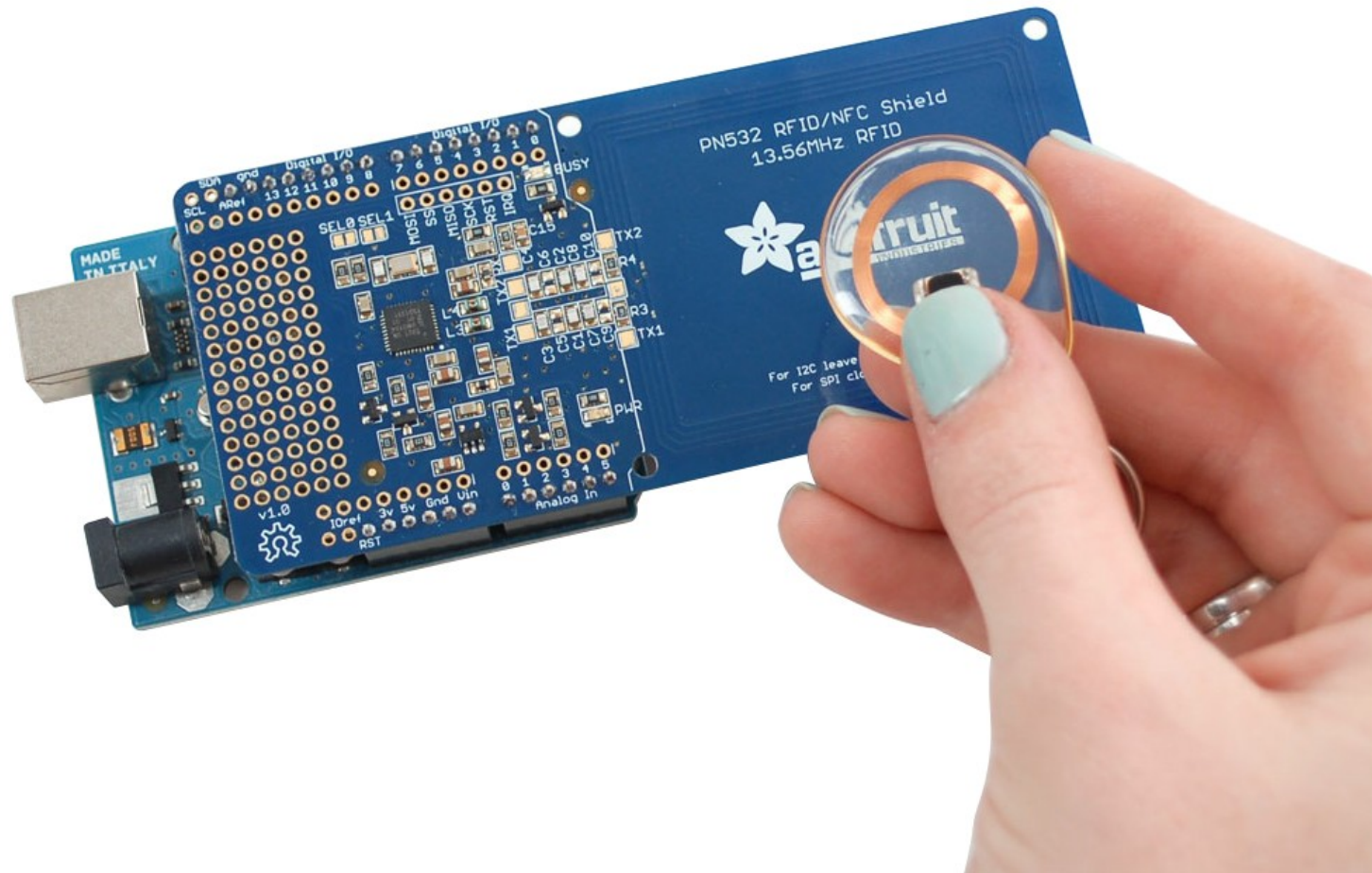

Motor Shield

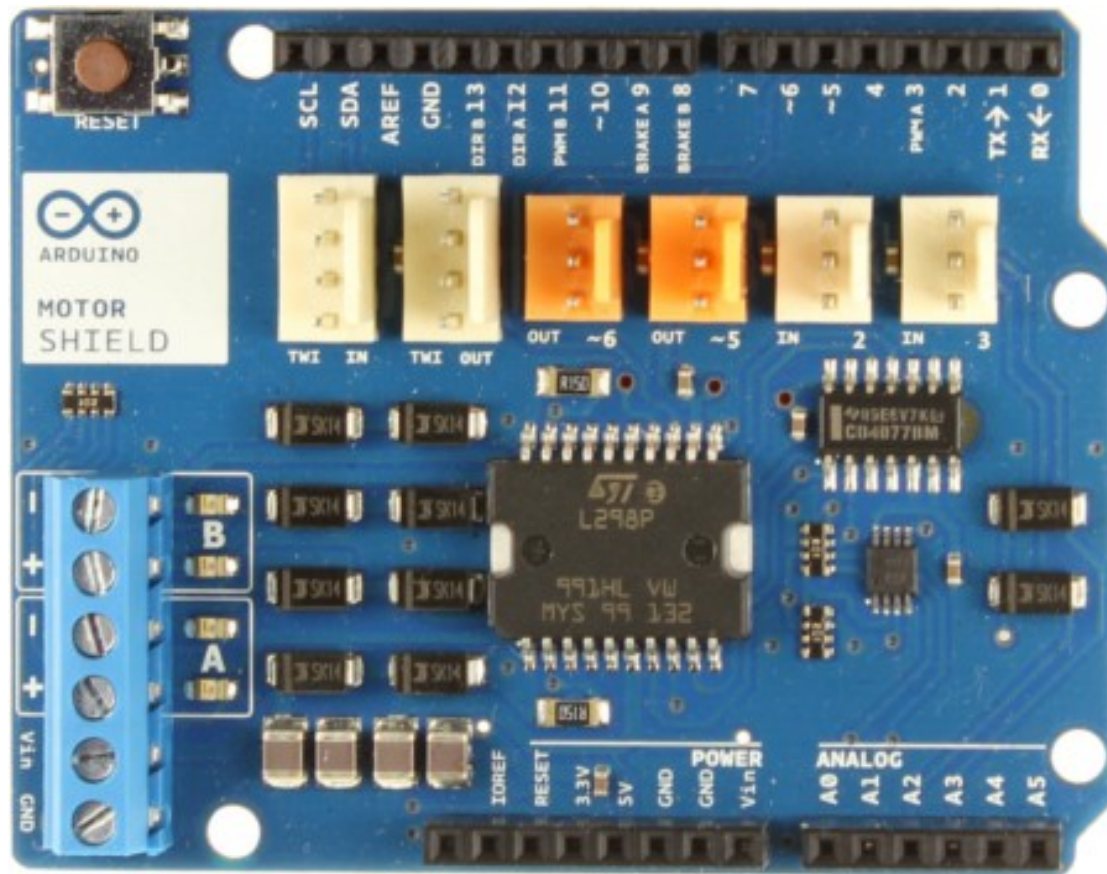

Esercizi per casa

- Stampare la lettura del sensore (temperatura e umidità oppure accelerazione) sul display LCD;
- Creare una pagina web che permetta di monitorare un pulsante e accendere un led su arduino;
- Crearsi un proprio progetto, ad esempio un **termostato**:
 - Lettura temperatura dalla termoresistenza
 - Stampa temperatura su display LCD
 - Regolazione soglia temperatura con due bottoni
 - Accensione di un led per simulare il termosifone

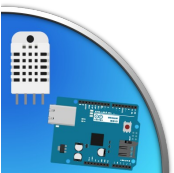

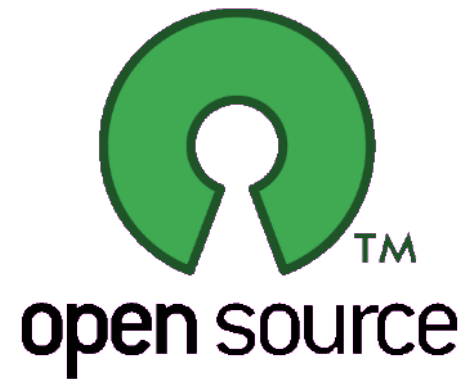

Presentazione realizzata con software open source
(LibreOffice Impress, Gimp, Arduino, Fritzing)

Quest'opera è distribuita con Licenza **CC-BY-SA**
e realizzata da *Stefano Panichi* e *Giulio Fieramosca*

